



reximex

"Aim for the next level."

About Reximex

Reximex was founded in Konya-Beyşehir in 2015. Our main goal is to produce world class products using the latest R&D and Manufacturing proficiency, with the guidance of our dynamic Management and Production team.

Reximex achieved a customer portfolio over 60 countries in a very short time with the vision of never compromise philosophy from quality, innovation and customer satisfaction.

We Have A Wide Product Range!

We always aim to respond to the expectations of our customers at the highest level. At the same time, we are always working on launching new products by following the global end-user trends very carefully.

We design customizable products!

We analyze our customers' conditions & area of use and personal preferences; and we design products that exceeds our customers' expectations. We reveal easily customizable products that maximizes the end-user experience.

We always bring our manufacturing skills to next level and keep up with the latest technologies!

Reximex production plant uses modern & latest technology equipment in an integrated production facility of 12.000 square meters. Our Production Facility & Crew is continuously developing and expanding in accordance with our customers' needs and our future business plans.



reximex



NEW

www.reximex.com

RIFLE / PANGEA







PANGEA

BOLT ACTION RIFLE



Pangea Classic LW22

AVAILABLE CALIBERS

-  .243 Win
-  6.5 Creedmoor
-  .308 Win (Available in Short Action)
-  .270 Win
-  .30-06 Springfield
-  .300 Win Mag. (Soon)
-  7 mm Rem Mag. (Soon) (Available in Long Action)

Completely, compatible with after market pre-fit Remington 700 Barrels



Microcell Recoil Pad Lead to Incredibly Light and Soft recoil Pad



Three-lug Locking with 60-degree Bolt Throw



Picatinny Rail Mounted on Receiver



5/8"X24 Muzzle Thread Optional



Bolt Release Button



Firing Pin Indicator



T-REX Trigger Systems Fully Adjustable Pull Weight of 2 - 4 lbs



Compatible with Rem 700 magazine variations

PANGEA

BOLT ACTION RIFLE



Pangea Classic LW22



Scan code for all options and colors

Barrel Length	20" / 22" / 24" (Optional 5/28" x 24 Muzzle Thread)
Barrel Contour	17mm (LW) 19mm (SW) 22mm (Match) w/(Optional Fluted)
Twist Rate	1:10 (4 grooves) (1:12 on Match Barrels)
Magazine	Floorplate 3+1
Magazine Compatibility	Rem 700 Box Mag. Variations.
Overall Length	40.41"
Average Weight	7.80 lbs

Bolt	Three-lug Locking with 60-degree Bolt Throw
Safety	Trigger Safety
Trigger	Fully adjustable pull weight of 2 - 4 lbs
Sight	Picatinny Rail Mounted on receiver
Accuracy	3-Shot Sub-Moa Guaranteed at 100 Yards with Premium Factory Ammunition
Stock	Selected Turkish Walnut, Oil Finished
Stock Compatibility	Rem 700 variations on Magpul – GRS – MDT - McMILLAN

NEW



Scan code for all options and colors

PANGEA

BOLT ACTION RIFLE



Pangea Modern SW20 w/Fluted Barrel

AVAILABLE CALIBERS

- 🎯 .243 Win
- 🎯 6.5 Creedmoor
- 🎯 .308 Win (Available in Short Action)
- 🎯 .270 Win
- 🎯 .30-06 Springfield
- 🎯 .300 Win Mag. (Soon)
- 🎯 7 mm Rem Mag. (Soon) (Available in Long Action)

Completely, compatible with after market pre-fit Remington 700 Barrels

Barrel Length	20" / 22" / 24" (Optional 5/28" x 24 Muzzle Thread)	Bolt	Three-lug Locking with 60-degree Bolt Throw
Barrel Contour	17mm (LW) 19mm (SW) 22mm (Match) w/(Optional Fluted)	Safety	Trigger Safety
Twist Rate	1:10 (4 grooves) (1:12 on Match Barrels)	Trigger	Fully adjustable pull weight of 2 - 4 lbs
Magazine	Floorplate 3+1	Sight	Picatinny Rail Mounted on receiver
Magazine Compatibility	Rem 700 Box Mag. Variations.	Accuracy	3-Shot Sub-Moa Guaranteed at 100 Yards with Premium Factory Ammunition
Overall Length	40.15"	Stock	Selected Turkish Walnut, Oil Finished
Average Weight	8.25 lbs	Stock Compatibility	Rem 700 variations on Magpul – GRS – MDT - McMILLAN



Fluted Barrel (Optional)



5/8"X24 Muzzle Thread (Optional)

www.reximex.com

RIFLE / PANGEA



Scan code for all options and colors

PANGEA HUNTER

BOLT ACTION RIFLE



Pangea Hunter LW22

AVAILABLE CALIBERS

- .243 Win
- 6.5 Creedmoor
- .308 Win (Available in Short Action)
- .270 Win
- .30-06 Springfield
- .300 Win Mag. (Soon)
- 7 mm Rem Mag. (Soon) (Available in Long Action)

Completely, compatible with after market pre-fit Remington 700 Barrels

Barrel Length 20" / 22" / 24" (Optional 5/28" x 24 Muzzle Thread)

Barrel Contour 17mm (LW) 19mm (SW) 22mm (Match) w/(Optional Fluted)

Twist Rate 1:10 (4 grooves)

Magazine Floorplate 3+1

Magazine Compatibility Rem 700 Box Mag. Variations.

Overall Length from 44" to 45" (w/24" Barrel)

Average Weight 7.00 lbs

Bolt Three-lug Locking with 60-degree Bolt Throw

Safety Trigger Safety

Trigger Fully adjustable pull weight of 2 - 4 lbs

Sight Picatinny Rail Mounted on receiver

Accuracy 3-Shot Sub-Moa Guaranteed at 100 Yards with Premium Factory Ammunition

Stock Polymer Stock with 3 Spacer for LOP and Adjustable Cheek Riser

Stock Compatibility Rem 700 variations on Magpul – GRS – MDT - McMILLAN



3 Spacers for length of pull adjustment. (0.2", 0.35" and 0.55" width). Stock Length of pull can be extended from 13.25"

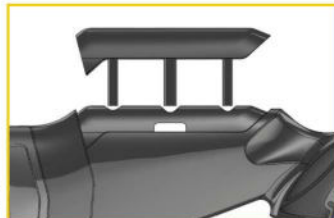

Adjustable Cheek Riser



Remington 700 foot prints means compatible with all aftermarket stocks and trigger systems.

NEW

www.reximex.com

HANDGUN / TRX9



Scan code for all options and colors

TRX9

SEMI AUTOMATIC PISTOL



CALIBER
9X19 mm



BARREL LENGTH
113 mm / 4.45 "



MAG. CAPACITY
15 Round
Steel Magazine



SYSTEM
Semi Auto
Striker-Fired



WEIGHT
without magazine
696 g / 24.55 oz



WEIGHT
with empty magazine
776 g / 27.34 oz

BEYOND THE SAFETY STANDARDS



TRIGGER SAFETY



STRIKER STATUS INDICATOR



LOADED CHAMBER INDICATOR

TRX9

TRX 9 pistol is designed and produced with stricter safety systems to prevent unintentional discharge should the pistol be dropped or misused. Trigger Safety, Firing Pin Block, Striker Status Indicator & Loaded Chamber Indicator provides the ultimate shooting pleasure for everyone with the safety in mind.

NEW

www.reximex.com

HANDGUN / TRX9



OVERSIZE TRIGGER GUARD

TRX9 features an oversized trigger guard for use with gloved hands.

TEXTURED INDEXING POINTS

Indexing points on the TRX 9 are textured for an extra-firm grip and more ergonomic handling.

MAGWELL

Every TRX9 comes with custom design Magwell making change of magazines much smoother, faster and easier.

REVERSIBLE MAGAZINE CATCH

ADVANCED TEXTURE

Progressive design texture of TRX9 pistol provides smooth touch and firm grip during handling and shooting.

2 BACKSTRAP SIZES

TRX9 comes with 2 modular backstraps in medium and large sizes for different trigger distances.

Backstraps are made of elastomer polymer and together with the special design surface texture on them, you have a much comfortable and softer feel in your palm.



MIL-STD 1913 PICATINNY RAIL

Slide incorporates a Mil-Std 1913 Picatinny Rail for suitable sighting devices-such as laser sights- or flashlights.

FAST FIELD STRIPPING

Field stripping the TRX9 is toolless and can be done in a few seconds at the touch of a button and simply by lifting up the slide. Take down button locks back when the slide is installed back into the chassis.

OPTICS-READY SLIDE

Steel slide is equipped with metal rear and front sight installed. Red Dot Sights or other compatible optic sights can easily be installed on the Optic Mount Slot on the slide.

Compatible with " Trijicon RMRcc and Shield RMS/RMSc "



NEW

www.reximex.com

HANDGUN / TRX9

NEW

www.reximex.com

HANDGUN / TRX9

DOUBLE STACK METAL MAGAZINE

Metal construction and custom design magazines are made for long durability and severe endurance.

2 magazines in 15 round capacity (double stack) are included.



AGGRESSIVE SERRATIONS FOR EASIER MANIPULATION



AMBIDEXTROUS HOLSTER FOR BOTH RIGHT AND LEFT HAND USERS.
SIDE CLIP CAN EASILY BE REVERSED FOR LEFT HAND USERS.



UNIQUE DESIGN HOLSTER

AMBIDEXTROUS

TRX9 is equipped with an ambidextrous slide stop and reversible magazine release. Ambidextrous grip is made of advanced polymer and designed to fit perfectly to both right- and left-hand shooters.



CUSTOM DESIGN POLYMER HANDGUN CASE



TECHNICAL SPECIFICATIONS

• Firing System	Semi-Auto Striker-Fired
• Caliber	9x19mm
• Type	Compact Size
• Magazine Capacity	15 round - Steel Magazine
• Slide	Oxidation Proof -Chromium, Nickel, Molybdenum Forged Steel
• Lower Frame	Advanced Polymer
• Barrel	Oxidation Proof -Chromium, Nickel, Molybdenum Steel Barrel
• Barrel Length	107.95mm / 4.25"
• Rate of Twist	1:10 w/6 grooves
• Sights	Metal Rear and Front Sight 3 White Dots Optic Mount Slot for Red Dot Sights (1.61" length)
• Weight without magazine	696 gram /24.55 ounces
• Weight w/empty magazine	776 gr / 27.34 ounces
• Features	Reversible Magazine Catch Mag-Well MIL-STD-1913 Picatinny Rail Modular Backstraps (M and L sizes) Ambidextrous Slide Release
• Safety Systems	Trigger Safety Firing Pin Block Loaded Chamber Indicator (LCI) Striker Status Indicator



1
LENGTH (OVERALL)
7.56"

2
SLIDE LENGTH
7.29"

3
WIDTH (OVERALL)
1.18"

4
SLIDE WIDTH
1.03"

5
HEIGHT INC. MAG.
5.22"

6
TRIGGER DISTANCE
2.73"

7
LINE OF SIGHT
6.30"

NEW

www.reximex.com

HANDGUN / TRX9

TRX9

Color Options



DuoTone
Tungsten



DuoTone
Midnight Bronze



DuoTone
OD Green



DuoTone
Desert Sand



Sniper Gray



Magpul FDE



Black

TRX9

TRX9 C18



Pistol Compensator



18 Round Extended Magazine



1/2"X28 Muzzle Thread

NEW

www.reximex.com

HANDGUN / TRX9

NEW

www.reximex.com

HANDGUN / TRX9

TRX9

TRX9 C18



Scan code for all options and colors

TECHNICAL SPECIFICATIONS

• System	Single Action Trigger, Striker-Fired Semi-Auto
• Caliber	9x19mm
• Type	Full Size
• Magazine Capacity	18 round - Steel Magazine
• Slide	Oxidation Proof -Chromium, Nickel, Molybdenum Steel
• Lower Frame	Advanced Polymer
• Barrel	Oxidation Proof -Chromium, Nickel, Molybdenum Steel Drilled Barrel
• Barrel Length	125mm / 4.92"
• Rate of Twist	1:10 w/6 grooves
• Sights	Metal Rear and Front Sight 3 White Dots Optic Mount Slot for Red Dot Sights (1.61" length)
• Weight without magazine	727 gram /25.64 oz
• Weight w/empty magazine	807 gr / 28.46 oz
• Features	Reversible Magazine Catch Mag-Well MIL-STD-1913 Picatinny Rail Modular Backstraps (M and L sizes) Ambidextrous Slide Release
• Safety Systems	Trigger Safety Firing Pin Block Loaded Chamber Indicator (LCI) Striker Status Indicator



1
LENGTH (OVERALL)
208.4 mm / 8.20"

2
SLIDE LENGTH
185.35 mm / 7.29"

3
WIDTH (OVERALL)
30.20 mm / 1.18"

4
SLIDE WIDTH
26.20 mm / 1.03"

5
HEIGHT INC. MAG.
150.7 mm / 5.93"

6
TRIGGER DISTANCE
69.50 mm / 2.73"

7
LINE OF SIGHT
160.20 mm / 6.30"

TRX9

TRX9 C18



SPORT



FDE



Fluted Barrel & Sport Slide



NEW

www.reximex.com

HANDGUN / TRX9

NEW

RS 912

www.reximex.com

OVER&UNDER SHOTGUN / RS 912



RS 912 Silver

Model	RS 912
System	Single Selective Trigger O/U w/Ejector
Gauge	12Ga
Chamber	76mm
Available Barrel Lengths	66cm/71cm and 76cm & 51cm Barrel with Slug Version
Receiver	Steel
Stock	Turkish Walnut
Weight (w/71cm Barrel)	3,3kg
Total Length(w/71cm Barrel)	115cm
Safety	Top Tang Barrel Selector and Safety



RS 912 Black



RS 912 High Rib Sporting Over/Under Shotgun

Ventilated and solid mid-rib options

DuoForm butt pad offers non-stick upper surface for faster and smoother shouldering, while the rough textured lower surface stops the gun properly and securely into place.



Scan code for all options and colors



RS 912 ELITE BLACK
GRADE # 2 TURKISH WALNUT STOCK
EXTENDED CHOKE



RS 912 BLACK
GRAY LAMINATED w/Adj.Cheek Piece
EXTENDED CHOKE

NEW

www.reximex.com

OVER&UNDER SHOTGUN / RS 912



RS 512



COREX[®]
Advanced Recoil Absorber System
Reduces the recoil for consistent shooting experience

Quick Detach Sling (QD)

Unique Shims for adjustment of drop and cast provides personalized aiming

The two-parts receiver made from 7075 aluminum for a lightweight design.

Bolt with carburized rotating bolt head is locked into the barrel.

Anti-Slip textured Rubber Inlay Synthetic Stock and forearm for better handling

www.reximex.com

SEMI AUTO SHOTGUN / RS 512

Model	RS 512
System	Gas operated semi auto w/rotating bolt head locking
Gauge	12Ga
Chamber	76mm
Available Barrel Lengths	66cm / 71cm / 76 and 81cm
Receiver	Anodized Aluminium
Magazine Capacity	5+1 / 7+1 / 9+1
Stock	Synthetic - Rubber Inlay Anti-Slip Textured
Trigger Guard	Techno Polymer

Recoil Pad	Microcell Recoil Pad
Weight (w/71cm Barrel)	3,1kg
Total Length(w/71cm Barrel)	125cm
Safety	Cross-Bolt Trigger Safety
Sight	Front Fiber Optic
Choke	90mm REX Chokes C/IC/M/IM/F
Shim Kit	5 Shims for Adjustment of Drop and Cast



RS 512 SILVER

Quick Detach Sling (QD)

90 mm REXtra chokes for better pattern and knurled to allow for quick and easy removal or installation

Scan code for all options and colors



RS 512 DESERT SAND



RS 512 ARMY GREEN



RS 512 WOOD



RS 512 SHADOW GRASS CAMO



RS 212



Ergonomic designed Anti-Slip Textured TechnoPolymer stock and forearm for better handling

Unique Shims for adjustment of drop and cast provides personalized aiming

Oversized trigger guard suits for use in all conditions

Stylish conical designed receivers are adapted for superior durability

www.reximex.com

SEMI AUTO SHOTGUN / RS 212

Model	RS 212
System	Gas Operated Semi Auto
Gauge	12Ga
Chamber	76mm
Available Barrel Lengths	66cm/71cm/76cm/ and 81cm
Receiver	Aluminium
Magazine Capacity	5+1/7+1/9+1
Stock	Synthetic - Anti Slip Textured
Trigger Guard	Techno Polymer

Recoil Pad	High Density PU Material
Weight (w/71cm Barrel)	3,15kg
Total Length (w/71cm Barrel)	123cm
Safety	Cross-Bolt Trigger Safety
Sight	Front Fiber Optic
Choke	70mm REX Chokes C/IC/M/IM/F
Shim Kit	5 Shims for Adjustment of Drop and Cast



RS 212 FDE



RS 212 BLACK



RS 212 MAGNA



Scan code for all options and colors

Magna available with 7+1/
9+1 rounds magazine with
an oversized bolt handle &
release button.



NEW



RS 512 HD

Consistent Shooting Experience

Advanced Recoil Absorber System reduces the recoil for consistent shooting experience (*available on Synthetic version).



Shims

5pcs unique shims for adjustment of drop and cast provides personalized aiming

Receiver

The receiver made from 7075 aluminum and aluminum cover make for a lightweight design.

Recoil Pad

The design and the innovative material of Microcell recoil pad lead to incredibly light and soft recoil pad.



Better Handling

Anti-Slip Textured Rubber Inlay Synthetic stock for better handling



QD Socket

QD socket for quick disconnection system

Bolt with carburized rotating bolt head is locked into the barrel



www.reximex.com

TACTICAL SHOTGUN / RS 512 HD

Model	RS 512 HD
System	Gas operated semi auto w/rotating bolt head locking
Gauge	12Ga
Chamber	76mm
Available Barrel Lengths	51cm
Receiver	Anodized Aluminum
Magazine Capacity	7+1
Stock	Synthetic - Rubber Inlay Anti-Slip Textured

Trigger Guard	Techno Polymer
Recoil Pad	Microcell Recoil Pad
Weight	3,1kg
Total Length	105cm
Safety	Cross-Bolt Trigger Safety
Sight	Tactical Rear & Front Sight
Choke	Choked Barrel



Forcing Cone
BoREX barrels are backbored
and lightened forcing cone

Tactical Front Sight

COREX[®]
Advanced Recoil Absorber System
Reduces the recoil for consistent
shooting experience.

RS 512 HD BLACK

Faster Loading
Oversized trigger guard suits
for use in all conditions
and redesigned
for faster loading



Fore-end



RS 512 HD SNIPER GREY



Scan code for all options and colors

www.reximex.com

TACTICAL SHOTGUN / RS 512 HD

NEW

NEW



TACTICAL & HOME DEFENCE



Scan code for all options and colors



RS 212 HD FDE



RS 212 HD

www.reximex.com

TACTICAL SHOTGUN / RS 212

System	Semi-Auto
Gauge	12Ga
Chamber	76mm
Available Barrel Lengths	51cm
Receiver	Anodized Aluminium
Magazine Capacity	7+1
Stock	Synthetic - Anti-Slip Textured
Trigger Guard	Techno Polymer

Recoil Pad	High Density PU Material
Weight	2.6kg
Total Length	99.8 cm
Safety	Cross-Bolt Trigger Safety
Sight	Tactical Rear & Front Sight
Shim Kit	5 Shims for Adjustment of Drop and Cast

NEW

www.reximex.com

TACTICAL SHOTGUN / RS 412



RS 412 HD



RS 412 GUARD



RS 412 HD SKULL

System	Pump Action
Gauge	12Ga
Chamber	76mm
Available Barrel Lengths	51cm
Receiver	Anodized Aluminium
Magazine Capacity	7+1
Stock	Synthetic - Anti-Slip Textured

Recoil Pad	High Density PU Material
Weight	2.6kg
Total Length	99.8 cm
Safety	Cross-Bolt Trigger Safety
Sight	Rear & Front Sight
Shim Kit	5 Shims for Adjustment of Drop and Cast
Trigger Guard	Techno Polymer

PCP AIRGUNS

PCP AIRGUNS





90cc
Pre-Chamber



1 CLICK 14 MPa
100

1 14 18 20 24 28 32

KE

0.431
USED NR

ACCURA CARBON

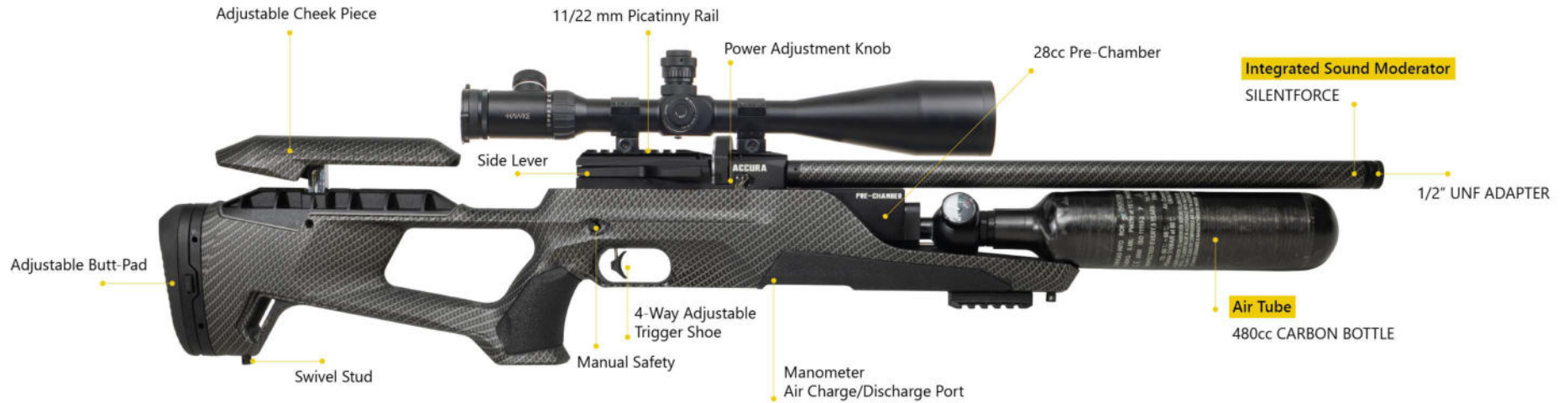

Model	Accura Carbon			
Cocking System	Side Lever			
Caliber	4.5mm / .177cal	5.5mm / .22cal	6.35mm / .25cal	
Max. Muzzle Velocity	274m/s (900fps)	259m/s (850fps)	224m/s (800fps)	
Energy(*)	Joules	20.6	39.6	49.1
	ft.lbs	15.18	29.1	36.1
Magazine Capacity	14	12	10	
Number of Shots at Optimal Velocity (250-100bar)	110	90	75	
Air Tube Volume	480cc Carbon Bottle			
Fill Pressure	250 BAR			
Regulator	Included , 28CC Pre-Chamber			

Stock	High Quality Synthetic Stock w/Adjustable Cheek Piece (Shown on Picture) Other Option : Turkish Walnut Stock w/Adjustable Cheek Piece
Overall Length	1010mm (39.7")
Barrel Length	420mm (16.5")
Weight	Synthetic: 3.5kg (7.7lbs) / Turkish Walnut: 3.1kg (6.8lbs)

* Velocity figures are tested with 8.44grain 177cal- 18.13grain 22cal and 25.39grain 25cal JSB pellets

* Velocity/Energy results may due to pellet weight, pellet shape, temperature, elevation, as well as other factors.

* Scope is not included



Anti-Slip Textured TechnoPolymer

Anti-Slip textured handgrip and forearm designed for better handling.

DAYSTAR W Carbine



Model	Daystar W Carbine			
Cocking System	Side Lever			
Caliber	4.5mm / .177cal	5.5mm / .22cal	6.35mm / .25cal	
Max. Muzzle Velocity	350m/s (1150fps)	290m/s (950fps)	260m/s (850fps)	
Energy(*)	Joules	33.6	49.3	55.2
	ft.lbs	24.8	36.3	40.7
Magazine Capacity	14	12	10	
Number of Shots at Optimal Velocity (250-100bar)	60	50	45	
Air Tube Volume	130 cc			
Fill Pressure	250 BAR			

Stock	Turkish Walnut Stock w/Adjustable Cheek Piece (Shown on Picture) Other Option : High Quality Synthetic Stock w/Adjustable Cheek Piece
Overall Length	890mm (35")
Barrel Length	420mm (16.5")
Weight	Synthetic: 2.4 Kg (5.2lbs) / Turkish Walnut: 2.8 Kg (6.1lbs)
Regulator	Included

* Velocity figures are tested with 8.44grain 177cal- 18.13grain 22cal and 25.39grain 25cal JSB pellets

* Velocity/Energy results may due to pellet weight, pellet shape, temperature, elevation, as well as other factors.

* Data may vary on products with optional regulator.

* Scope is not included

NEW PRODUCT

www.reximex.com

NYX COMPACT CARBON

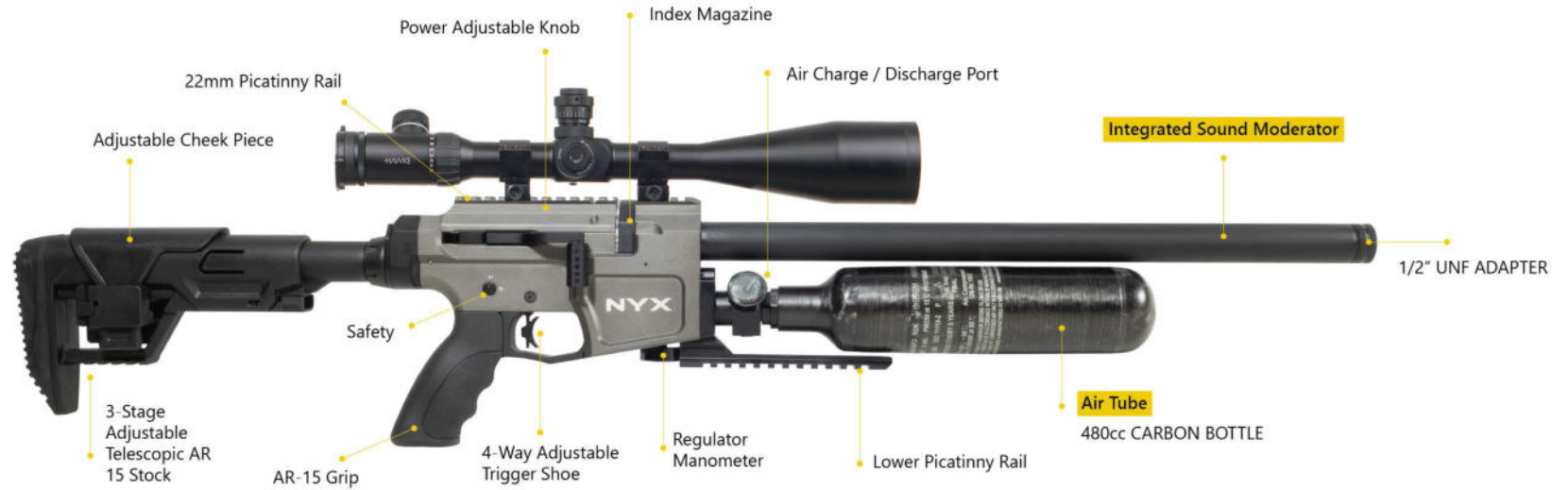

Model	NYX Compact Carbon			
Cocking System	Side Lever			
Caliber	4.5mm / .177cal	5.5mm / .22cal	6.35mm / .25cal	
Max. Muzzle Velocity	308m/s (1000fps)	274m/s (900fps)	243 m/s (800fps)	
Energy(*)	Joules	25.4	44.3	48.9
	ft.lbs	18.7	32.6	36.09
Magazine Capacity	14	12	10	
Number of Shots at Optimal Velocity (250-100bar)	90	75	75	
Air Tube Volume	480cc Carbon Bottle			
Fill Pressure	250 BAR			

Stock	Tactical Telescopic Stock Adjustable Cheek Piece.
Overall Length	820 mm / 32.2"
Barrel Length	380 mm / 14.96"
Weight	3.5 kg (7.70 lbs)
Regulator	Included

* Velocity figures are tested with 8.44grain 177cal- 18.13grain 22cal and 25.39grain 25cal JSB pellets
 * Velocity/Energy results may due to pellet weight, pellet shape, temperature, elevation, as well as other factors.

LIEVA



LIEVA SILVER

Model	LIEVA		
Cocking System	Lever Action		
Caliber	4.5mm / .177cal	5.5mm / .22cal	6.35mm / .25 LIEVA Number
Max. Muzzle Velocity	274,3 m/s / 900 fps	228,6 m/s 750 fps	198,1 m/s 650 fps
Energy(*)	Joules	20,64	30,80
	ft.lbs	15,18	22,65
Magazine Capacity	14	12	10
Number of Shots at Optimal Velocity (250-100bar)	60	40	40
Air Tube Volume	105cc		
Fill Pressure	250 BAR		

Stock	Turkish Walnut
Overall Length	980 mm / 38.58 "
Barrel Length	520 mm / 20.4"
Weight	2.2 kg (4.85 lbs)
Regulator	Included

*Velocity figures are tested with 8.44 grain 177 cal - 18.13 grain 22 cal and 25.39 grain 25 cal JBS pellets.
 *Velocity/Energy results may due to pellet weight, pellet shape, temperature, elevation, as well as other factors.

NEW PRODUCT

www.reximex.com

NEW PRODUCT

LYRA-K S

Adjustable
Butt Pad

Synthetic Stock

4 Way Adjustable Trigger
& Manual Safety





Power Adjustment Knob

Integrated Sound Moderator & 1/2 UNF Thread Size

250 BAR / 250 cc

Model	Lyra-K S		
Cocking System	Side Lever		
Caliber	4.5mm / .177cal	5.5mm / .22cal	6.35mm / .25cal
Max. Muzzle Velocity	305m/s (1000fps)	275m/s (900fps)	244m/s (800fps)
Energy(*)	Joules	31.6	50.8
	ft.lbs	23.3	37.5
Magazine Capacity	14	12	10
Number of Shots at Optimal Velocity (250-100bar)	100	70	60
Air Tube Volume	250cc		

Fill Pressure	250 BAR
Stock	Synthetic
Overall Length	880mm (34,6")
Barrel Length	380 mm / 14.96"
Weight	2.65 kg (5.8 lbs)

* Velocity figures are tested with 8.44grain 177cal-18.13grain 22cal and 25.39grain 25cal JSB pellets.

* Velocity/Energy results may be due to pellet weight, pellet shape, temperature, elevation, as well as other factors.

NEW PRODUCT

www.reximex.com

LYRA S



LYRA S FDE

Model	Lyra S		
Cocking System	Side Lever		
Caliber	4.5mm / .177cal	5.5mm / .22cal	6.35mm / .25cal
Max. Muzzle Velocity	350m/s (1115fps)	290m/s (965fps)	260m/s (850fps)
Energy(*)	Joules	31.6	50.8
	ft.lbs	23.3	37.5
Magazine Capacity	14	12	10
Number of Shots at Optimal Velocity (250-100bar)	110	75	65
Air Tube Volume	280cc		

Fill Pressure	200 BAR
Stock	High Quality Synthetic Stock, Adjustable Butt Pad
Overall Length	1070 mm (41.3")
Barrel Length	580 mm (22.8")
Weight	3.45 kg (7.6 lbs)

* Velocity figures are tested with 8.44 grain 177 cal- 18.13 grain 22 cal and 25.39 grain 25cal JSB pellets

* Velocity/Energy results may due to pellet weight, pellet shape, temperature, elevation, as well as other factors.

* Scope is not included.

LYRA-BP



Model	LYRA BP			Fill Pressure	200 Bar
Cocking System	Side Lever			Stock	Turkish Walnut
Caliber	4.5mm / .177cal	5.5mm / .22cal	6.35mm / .25cal	Overall Length	625mm (24.6")
Max Muzzle Velocity (*)	305m/s (1000fps)	275m/s (900fps)	244m/s (800fps)	Barrel Length	420mm (16,5")
Energy (*)	31.6 Joule/ 23.3 ft.lbs	50.8 Joule/ 37.5 ft.lbs	55.4 Joule/ 40.7 ft.lbs	Weight	Weight 3.1 kg (6.8 lbs)
Magazine Capacity	14	12	10	* Velocity figures are tested with 8.44grain 177cal- 18.13grain 22cal and JSB pellets	
Number of Shots	60	45	35	*Velocity/Energy results may due to pellet weight, pellet shape, temperature, elevation, as well as other factors.	
Air Tube Volume	210cc				

NEW PRODUCT

www.reximex.com

TORMENTA LITE SERIES



TORMENTA LITE



TORMENTA W LITE
Turkish Walnut Stock

Model	Tormenta Lite	
Cocking System	Side Lever	
Caliber	4.5mm / .177 , 5.5mm / .22 , 6.35mm / .25	
Max.Muzzle Velocity(*)	290 m/s / 950 fps , 259 m/s 900 fps , 243 m/s 800 fps	
Energy (*)	Joules	22.99 / 44.34 / 49.08
	ft.lbs	16.91 / 32.61 / 36.09
Magazine Capacity	14 , 12 , 10	

Number Of Shots At Optimal Velocity(200-100 Bar)	75, 65, 65
Air Tube Volume	130cc
Fill Pressure	200 Bar
Stock	Adjustable AR Compatible Telescopic Adjustable Stock
Overall Length	850 mm / 33.4 "
Barrel Length	380 mm / 14.9 "
Weight	2.8 kg / 6.17 lbs
Regulator	Optional



12 gr CO2

MORPHO



Model	Morpho		
Powerplant	CO2		
Action	Side Lever		
Caliber	4.5mm / .177cal	5.5mm / .22cal	
Ammo	Pellet		
Muzzle Velocity (*)	400 fps / 121.9 m/s	350 fps / 106.6 m/s	
Energy(*)	Joules	4.07	4.93
	ft.lbs	2.99	6.70
Magazine Capacity	14	12	
Number Of Shot with 1x 12 gr CO2	40	36	

Power Source	1x 12 gr CO2
Barrel & Barrel Length	Rifled / 201mm (7.9")
Overall Length with Detachable Stock	612mm (24.09")
Weight with Detachable Stock	1.3 kg (2.9lbs)
Overall Length with Pistol Grip	370mm (14.5")
Weight with Pistol Grip	0.9 kg (1.98lbs)

* Velocity figures are tested with 8.44grain 177cal- 18.13grain 22cal and 25.39grain 25cal JSB pellets

* Velocity/Energy results may due to pellet weight, pellet shape, temperature, elevation, as well as other factors.

NEW PRODUCT

www.reximex.com

RP / RPA SILVER



Removable Air Tube
AIRCRAFT TECHNOLOGY
7075 ALUMINUM
SERIES AIR TUBE



Removable Air Tube
AIRCRAFT TECHNOLOGY
7075 ALUMINUM
SERIES AIR TUBE

Model	RPA SILVER	
Cocking System	SIDE LEVER	
Caliber	4.5mm / .177cal	5.5mm / .22cal
Maximum Muzzle Velocity	186m/s (610fps)	157m/s (515fps)
Energy	9.5 Joule / 7 ft.lbs	14.5 Joule / 10.7 ft.lbs
Magazine Capacity	9	7
Number of Shots At Optimal Velocity (250-110 Bar)	55	40
Air Tube Volume	50cc Aluminium (Removable)	
Fill Pressure	250 Bar	
Stock	Turkish Walnut / Optional Laminated Grip	

Overall Length	330 mm (13")
Barrel Length	200 mm (7.9")
Weight	900 grams (1.98 lbs)
Regulator	Standard

* Velocity figures are tested with 8.44 grain 177 cal- 18.13 grain 22 cal and 25.39 grain 25cal JSB pellets

* Velocity/Energy results may due to pellet weight, pellet shape, temperature, elevation, as well as other factors.

* Scope is not included.

RP 11

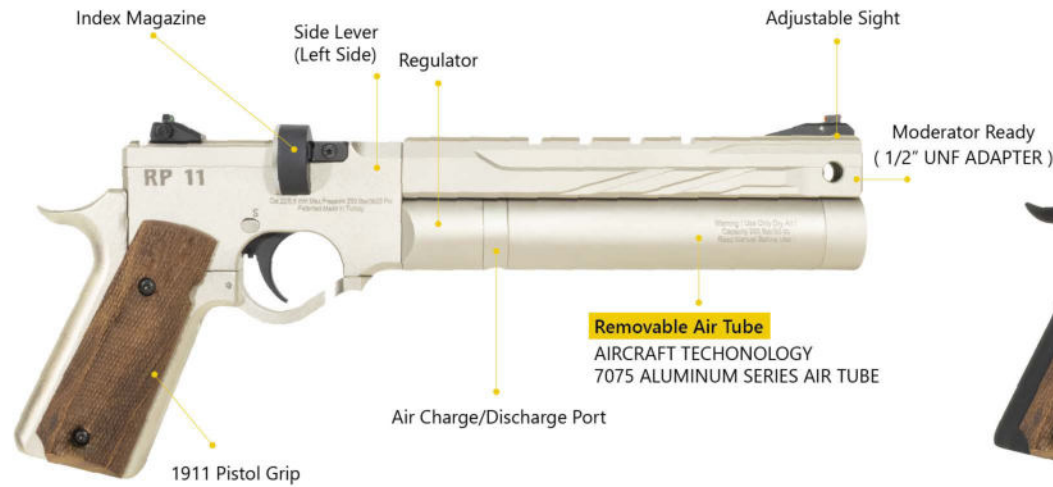

Aircraft Alloy T6 7075
Aluminum Series Tube

Removable Air Tube
AIRCRAFT TECHNOLOGY
7075 ALUMINUM SERIES AIR TUBE

Model	RP 11		
Cocking System	Side Lever		
Caliber	4.5mm / .177cal	5.5mm / .22cal	
Max. Muzzle Velocity	186 m/s (610fps)	157m/s (515fps)	
Energy(*)	Joules	9.5	14.5
	ft.lbs	7	10.7
Magazine Capacity	9	7	
Number of Shots at Optimal Velocity (250-100bar)	55	40	
Air Tube Volume	50cc Aluminium (removable)		
Fill Pressure	250 BAR		

Grip	Aluminum 1911 Pistol Grip
Overall Length	330mm (13")
Barrel Length	200mm (7.9")
Weight	1005 gram (2.21 lbs)
Regulator	Included

* Velocity figures are tested with 8.44grain 177ca and 18.13grain 22cal and 25.39 grain 25cal JSB pellets
 * Velocity/Energy results may due to pellet weight, pellet shape, temperature, elevation, as well as other factors.
 * Scope is not included

RP RACE



Cocking System	Side Lever	
Caliber	4.5mm / .177cal	5.5mm / .22cal
Max. Muzzle Velocity	186 m/s (610fps)	157m/s (515fps)
Energy(*)	Joules	9.5
	ft.lbs	7
Magazine Capacity	9	7
Number of Shots at Optimal Velocity (250-100bar)	55	40
Air Tube Volume	50cc Aluminium (removable)	
Fill Pressure	250 BAR	

* Velocity figures are tested with 8.44grain 177ca and 18.13grain 22cal and 25.39 grain 25cal JSB pellets

* Velocity/Energy results may due to pellet weight, pellet shape, temperature, elevation, as well as other factors.

* Scope is not included

RPA RACE



Aircraft Alloy T6 7075 Aluminum Series Tube

Grip	Synthetic & Walnut Stock
Overall Length	330mm (13")
Barrel Length	200mm (7.9")
Weight	900 grams (1.98 lbs)
Regulator	Included



Sporting Cocking Lever



New Tactical Trigger



New Optics-ready Plate (Compatible with "Trijicon RMRcc and Shield RMS/RMSc"

META LITE SERIES



Model	META PLUS LITE		
Cocking System	SIDE LEVER		
Caliber	4.5mm / .177cal	5.5mm / .22cal	6.35mm / .25cal
Maximum Muzzle Velocity	332m/s (1000fps)	269m/s (880fps)	243.8m/s (800fps)
Energy	25.4 Joule / 18.7 ft.lbs	42.2 Joule / 31.2 ft.lbs	48.9 Joule / 36.1 ft.lbs
Magazine Capacity	14	12	10
Number of Shots At Optimal Velocity (250-110 Bar)	225	155	160
Air Tube Volume	515cc (425cc Aluminum Bottle + 90cc Pre-Chamber)		
Fill Pressure	250 Bar		
Stock	Bullpup Design , Synthetic Stock		

Overall Length	780 mm (23.4")
Barrel Length	480 mm (18.8")
Weight	7.87 lbs & 3.1 kg
Regulator	Included

* Velocity figures are tested with 8.44 grain 177 cal- 18.13 grain 22 cal and 25.39 grain 25cal JSB pellets

* Velocity/Energy results may due to pellet weight, pellet shape, temperature, elevation, as well as other factors.

* Scope is not included.

Model	META LITE		
Cocking System	SIDE LEVER		
Caliber	4.5mm / .177cal	5.5mm / .22cal	6.35mm / .25cal
Maximum Muzzle Velocity	332m/s (1000fps)	269m/s (880fps)	243.8m/s (800fps)
Energy	25.4 Joule / 18.7 ft.lbs	42.2 Joule / 31.2 ft.lbs	48.9 Joule / 36.1 ft.lbs
Magazine Capacity	14	12	10
Number of Shots At Optimal Velocity (250-110 Bar)	125	85	80
Air Tube Volume	260cc		
Fill Pressure	250 Bar		
Stock	Bullpup Design , Synthetic Stock		

Overall Length	750 mm (29.5")
Barrel Length	480 mm (18.8")
Weight	7.87 lbs & 3.1 kg
Regulator	Included

* Velocity figures are tested with 8.44 grain 177 cal- 18.13 grain 22 cal and 25.39 grain 25cal JSB pellets

* Velocity/Energy results may due to pellet weight, pellet shape, temperature, elevation, as well as other factors.

* Scope is not included.

NEW PRODUCT

www.reximex.com

NEW



META Premium



Scan code for all options and colors

Model	META PREMIUM		
Cocking System	SIDE LEVER		
Caliber	4.5mm / .177cal	5.5mm / .22cal	6.35mm / .25cal
Maximum Muzzle Velocity	335.2m/s (1100fps)	304m/s (1000fps)	274m/s (900fps)
Energy	30.7 Joule / 22.6 ft.lbs	54.2 Joule / 40.2 ft.lbs	61.9 Joule / 45.6 ft.lbs
Magazine Capacity	14	12	10
Number of Shots At Optimal Velocity (250-110 Bar)	210	150	120
Air Tube Volume	570cc (480cc Carbon Bottle + 90cc Pre-Chamber)		
Fill Pressure	250 Bar		
Stock	Bullpup Design, High Quality Aluminium Stock 3-Axis Adjustable Butt Pad with Monopod		

Overall Length	1000 mm (39.3")
Barrel Length	700 mm (27.5")
Weight	4.2 kg (8.6 lbs)
Regulator	Standard

* Velocity figures are tested with 8.44 grain 177 cal- 18.13 grain 22 cal and 25.39 grain 25cal JSB pellets

* Velocity/Energy results may due to pellet weight, pellet shape, temperature, elevation, as well as other factors.

* Scope is not included.

NEW Meta Lite in synthetic stock is now available

www.reximex.com

PCP AIRGUNS / META PREMIUM

NEW



Meta Premium FDE

700mm long expert barrel provides more precise accuracy and tighter grouping at long range with slug ammo.



480cc Carbon Bottle

Meta Premium Desert Sand

www.reximex.com

PCP AIRGUNS / META PREMIUM

NEW



META Plus



Scan code for all options and colors



Model	META PLUS		
Cocking System	SIDE LEVER		
Caliber	4.5mm / .177cal	5.5mm / .22cal	6.35mm / .25cal
Maximum Muzzle Velocity	332m/s (1000fps)	269m/s (880fps)	243.8m/s (800fps)
Energy	25.4 Joule / 18.7 ft.lbs	42.2 Joule / 31.2 ft.lbs	48.9 Joule / 36.1 ft.lbs
Magazine Capacity	14	12	10
Number of Shots At Optimal Velocity (250-110 Bar)	225	155	160
Air Tube Volume	515cc (425cc Aluminum Bottle + 90cc Pre-Chamber)		
Fill Pressure	250 Bar		
Stock	Bullpup Design, High Quality Aluminium Stock 3-Axis Adjustable Butt Pad with Monopod		

Overall Length	780 mm (23.4")
Barrel Length	480 mm (18.8")
Weight	3.9 kg (8.6 lbs)
Regulator	Standard

* Velocity figures are tested with 8.44 grain 177 cal- 18.13 grain 22 cal and 25.39 grain 25cal JSB pellets

* Velocity/Energy results may due to pellet weight, pellet shape, temperature, elevation, as well as other factors.

* Scope is not included.

NEW Meta Lite in synthetic stock is now available

www.reximex.com

PCP AIRGUNS / META PLUS



NEW



Meta Plus FDE



330cc Carbon Bottle

Meta Plus-330cc Carbon bottle is lighter in weight.
(Number shots is about 20% less due less air volume.)

www.reximex.com

PCP AIRGUNS / META PLUS



META

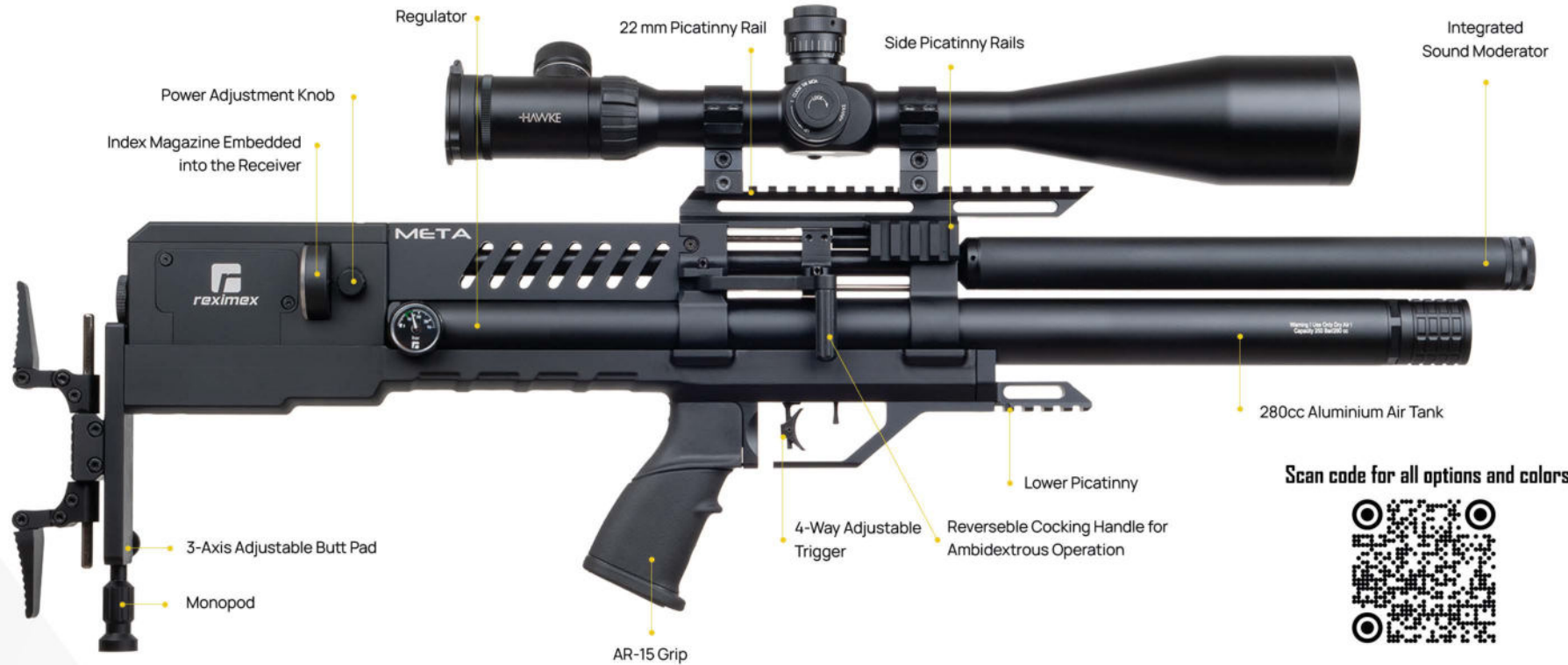

Scan code for all options and colors



Model	META		
Cocking System	SIDE LEVER		
Caliber	4.5mm / .177cal	5.5mm / .22cal	6.35mm / .25cal
Maximum Muzzle Velocity	332m/s (1000fps)	269m/s (880fps)	243.8m/s (800fps)
Energy	25.4 Joule / 18.7 ft.lbs	42.2 Joule / 31.2 ft.lbs	48.9 Joule / 36.1 ft.lbs
Magazine Capacity	14	12	10
Number of Shots At Optimal Velocity (250-110 Bar)	125	85	80
Air Tube Volume	260cc		
Fill Pressure	250 Bar		
Stock	Bullpup Design, High Quality Aluminium Stock 3-Axis Adjustable Butt Pad with Monopod		

Overall Length	750 mm (29.5")
Barrel Length	480 mm (18.8")
Weight	3.6 kg (7.9 lbs)
Regulator	Standard

* Velocity figures are tested with 8.44 grain 177 cal- 18.13 grain 22 cal and 25.39 grain 25cal JSB pellets

* Velocity/Energy results may due to pellet weight, pellet shape, temperature, elevation, as well as other factors.

* Scope is not included.

NEW Meta Lite in synthetic stock is now available



Meta Bronze



Meta OD Green



Throne Gen2



Model	THRONE GEN2		
Cocking System	SIDE LEVER		
Caliber	4.5mm / .177cal	5.5mm / .22cal	6.35mm / .25cal
Maximum Muzzle Velocity	310m/s (1010fps)	275m/s (935fps)	250m/s (830fps)
Energy	26 Joule / 19 ft.lbs	47.7 Joule / 35.2 ft.lbs	52.6 Joule / 38.8 ft.lbs
Magazine Capacity	14	12	10
Number of Shots At Optimal Velocity (250-110 Bar)	165	110	80
Air Tube Volume	425cc Aluminium (Optional 480cc Carbon Fiber Air Tank + 18cc Pre-Chamber)		
Fill Pressure	250 Bar		
Stock	Adjustable Butt Pad High Quality Synthetic Stock and Grip		

Overall Length	850 mm (33.5")
Barrel Length	580 mm (22.8")
Weight	3.5 kg (7.7 lbs)
Regulator	Externally Adjustable

* Velocity figures are tested with 8.44 grain 177 cal- 18.13 grain 22 cal and 25.39 grain 25cal JSB pellets

* Velocity/Energy results may due to pellet weight, pellet shape, temperature, elevation, as well as other factors.

* Scope is not included.

www.reximex.com

PCP AIRGUNS / THRONE GEN2



***Throne Gen2
Carbon Bottle***



***Throne Gen2
Desert Sand Carbon Bottle***



***Throne Gen2
Skull Camo***



***Throne Gen2
G1 Camo***



Scan code for all options and colors



Throne Gen2 Compact



Model	THRONE GEN2 COMPACT		
Cocking System	SIDE LEVER		
Caliber	4.5mm / .177cal	5.5mm / .22cal	6.35mm / .25cal
Maximum Muzzle Velocity	281m/s (925fps)	243m/s (800fps)	216m/s (745fps)
Energy	21.7 Joule / 16 ft.lbs	34.9 Joule / 25.8 ft.lbs	42.4 Joule / 31.3 ft.lbs
Magazine Capacity	14	12	10
Number of Shots At Optimal Velocity (250-110 Bar)	75	65	55
Air Tube Volume	300cc Carbon Bottle (18cc Pre-Chamber)		
Fill Pressure	250 Bar		
Stock	Adjustable Butt Pad High Quality Synthetic Stock and Grip		

Overall Length	700 mm (27.5")
Barrel Length	420 mm (16.5")
Weight	3.3 kg (7.3 lbs)
Regulator	Standard

* Velocity figures are tested with 8.44 grain 177 cal- 18.13 grain 22 cal and 25.39 grain 25cal JSB pellets

* Velocity/Energy results may due to pellet weight, pellet shape, temperature, elevation, as well as other factors.

* Scope is not included.



***Throne Gen2 Compact
Desert Sand***



***Throne Gen2 Compact
FDE***



RP



Adjustable Front Sight

RP Slide Color Options



Scan code for all options and colors



Model	RP	
Cocking System	SIDE LEVER	
Caliber	4.5mm / .177cal	5.5mm / .22cal
Maximum Muzzle Velocity	186m/s (610fps)	157m/s (515fps)
Energy	9.5 Joule / 7 ft.lbs	14.5 Joule / 10.7 ft.lbs
Magazine Capacity	9	7
Number of Shots At Optimal Velocity (250-110 Bar)	55	40
Air Tube Volume	50cc Aluminium (Removable)	
Fill Pressure	250 Bar	
Stock	Removable High Quality Synthetic Stock	

Overall Length	330 mm (13")
Barrel Length	200 mm (7.9")
Weight	900 grams (1.98 lbs)
Regulator	Standard

* Velocity figures are tested with 8.44 grain 177 cal- 18.13 grain 22 cal and 25.39 grain 25cal JSB pellets

* Velocity/Energy results may due to pellet weight, pellet shape, temperature, elevation, as well as other factors.

* Scope is not included.



RPA



**RPA
Blue
Laminated**



**RPA
Orange
Laminated**



Model	RPA	
Cocking System	SIDE LEVER	
Caliber	4.5mm / .177cal	5.5mm / .22cal
Maximum Muzzle Velocity	186m/s (610fps)	157m/s (515fps)
Energy	9.5 Joule / 7 ft.lbs	14.5 Joule / 10.7 ft.lbs
Magazine Capacity	9	7
Number of Shots At Optimal Velocity (250-110 Bar)	55	40
Air Tube Volume	50cc Aluminium (Removable)	
Fill Pressure	250 Bar	
Stock	Turkish Walnut / Optional Laminated Grip	

Overall Length	330 mm (13")
Barrel Length	200 mm (7.9")
Weight	900 grams (1.98 lbs)
Regulator	Standard

* Velocity figures are tested with 8.44 grain 177 cal- 18.13 grain 22 cal and 25.39 grain 25cal JSB pellets

* Velocity/Energy results may due to pellet weight, pellet shape, temperature, elevation, as well as other factors.

* Scope is not included.





NYX

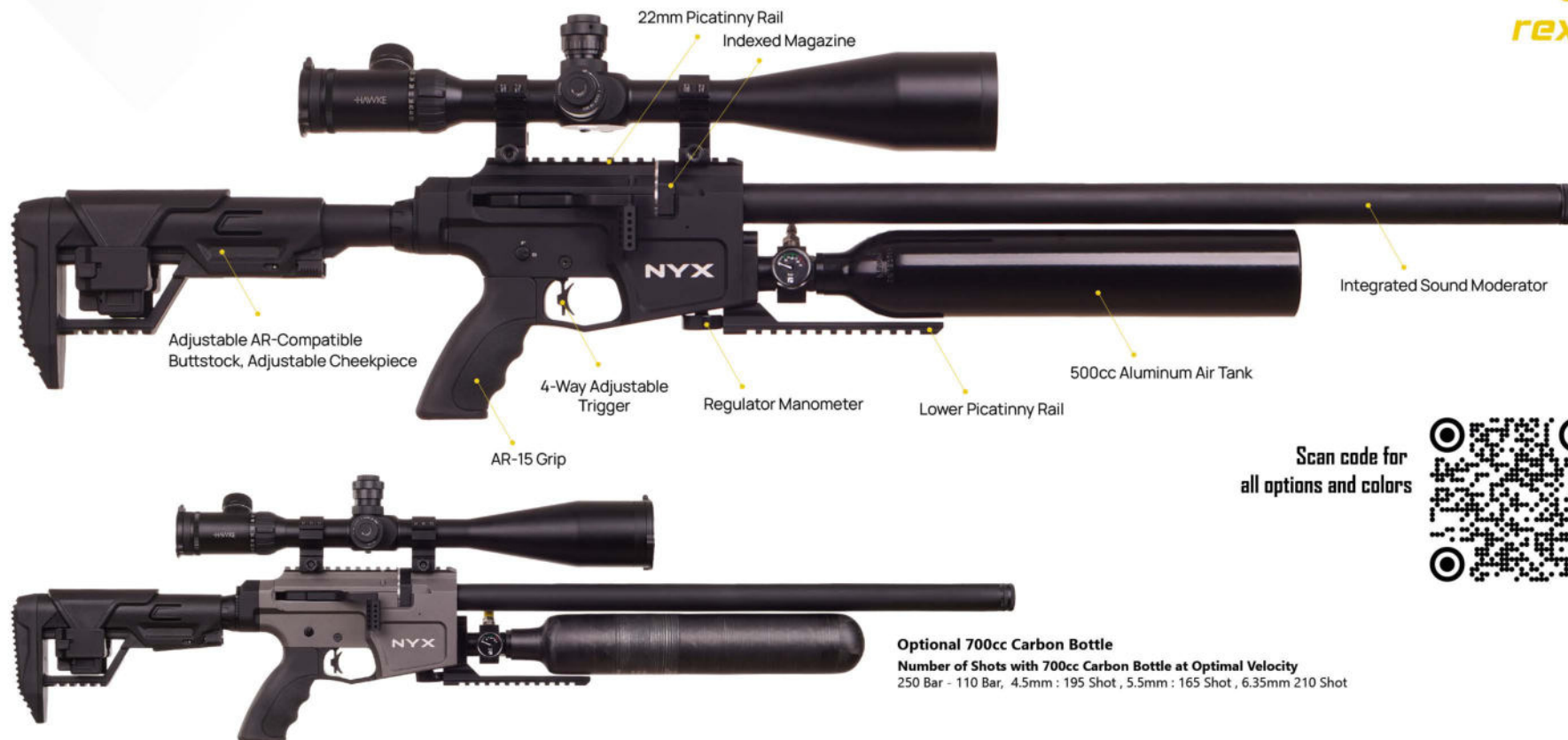

Scan code for all options and colors



Optional 700cc Carbon Bottle
Number of Shots with 700cc Carbon Bottle at Optimal Velocity
 250 Bar - 110 Bar, 4.5mm : 195 Shot , 5.5mm : 165 Shot , 6.35mm 210 Shot

Model	NYX		
Cocking System	SIDE LEVER		
Caliber	4.5mm / .177cal	5.5mm / .22cal	6.35mm / .25cal
Maximum Muzzle Velocity	308m/s (1000fps)	274m/s (900fps)	243m/s (800fps)
Energy	25.4 Joule / 18.7 ft.lbs	44.3 Joule / 32.6 ft.lbs	48.9 Joule / 36.09 ft.lbs
Magazine Capacity	14	12	10
Number of Shots At Optimal Velocity (250-110 Bar)	200	130	100
Air Tube Volume	500cc / Optional 700cc Carbon Bottle		
Fill Pressure	250 Bar		
Stock	Tactical Telescopic Stock Elevation Adjustable Cheek Rest.		

Overall Length	1050 mm (41.3")
Barrel Length	480 mm (18.8")
Weight	4.415 kg (9.813 lbs)
Regulator	Standard

* Velocity figures are tested with 8.44 grain 177 cal- 18.13 grain 22 cal and 25.39 grain 25cal JSB pellets

* Velocity/Energy results may due to pellet weight, pellet shape, temperature, elevation, as well as other factors.



ZONE



Scan code for all options and colors



Model	ZONE		
Cocking System	SIDE LEVER		
Caliber	4.5mm / .177cal	5.5mm / .22cal	6.35mm / .25cal
Maximum Muzzle Velocity	304m/s (1000fps)	270m/s (935fps)	255m/s (850fps)
Energy	25.4 Joule / 18.7 ft.lbs	47.7 Joule / 35.2 ft.lbs	55.2 Joule / 40.7 ft.lbs
Magazine Capacity	14	12	10
Number of Shots At Optimal Velocity (250-110 Bar)	75	65	55
Air Tube Volume	260cc		
Fill Pressure	250 Bar		
Stock	Bullpup Design High Quality Synthetic Stock, Adjustable Butt Pad		

Overall Length	900 mm (35.4")
Barrel Length	580 mm (22.8")
Weight	3.3 kg (7.27 lbs)
Regulator	Standard

* Velocity figures are tested with 8.44 grain 177 cal- 18.13 grain 22 cal and 25.39 grain 25cal JSB pellets

* Velocity/Energy results may due to pellet weight, pellet shape, temperature, elevation, as well as other factors.

* Scope is not included.

ZONE W



Model	ZONE W		
Cocking System	SIDE LEVER		
Caliber	4.5mm / .177cal	5.5mm / .22cal	6.35mm / .25cal
Maximum Muzzle Velocity	304m/s (1000fps)	270m/s (935fps)	255m/s (850fps)
Energy	25.4 Joule / 18.7 ft.lbs	47.7 Joule / 35.2 ft.lbs	55.2 Joule / 40.7 ft.lbs
Magazine Capacity	14	12	10
Number of Shots At Optimal Velocity (250-110 Bar)	75	65	55
Air Tube Volume	260cc		
Fill Pressure	250 Bar		
Stock	Turkish Walnut		

Overall Length	900 mm (35.4")
Barrel Length	580 mm (22.8")
Weight	3.3 kg (7.27 lbs)
Regulator	Standard

* Velocity figures are tested with 8.44 grain 177 cal- 18.13 grain 22 cal and 25.39 grain 25cal JSB pellets

* Velocity/Energy results may due to pellet weight, pellet shape, temperature, elevation, as well as other factors.

* Scope is not included.



APEX



Scan code for all options and colors



Model	APEX		
Cocking System	SIDE LEVER		
Caliber	4.5mm / .177cal	5.5mm / .22cal	6.35mm / .25cal
Maximum Muzzle Velocity	340m/s (1110fps)	270m/s (880fps)	255m/s (830fps)
Energy	31.3 Joule / 23.1 ft.lbs	42.3 Joule / 31.2 ft.lbs	53.9 Joule / 39.8 ft.lbs
Magazine Capacity	14	12	10
Number of Shots At Optimal Velocity (250-110 Bar)	112	96	80
Air Tube Volume	310cc		
Fill Pressure	250 Bar		
Stock	Bullpup Design High Quality Synthetic Stock Adjustable Butt Pad		

Overall Length	850 mm (33.4")
Barrel Length	480 mm (18.9")
Weight	3 kg (6.6 lbs)
Regulator	Optional

* Velocity figures are tested with 8.44 grain 177 cal- 18.13 grain 22 cal and 25.39 grain 25cal JSB pellets

* Velocity/Energy results may due to pellet weight, pellet shape, temperature, elevation, as well as other factors.

*Data may vary on products with optional regulator.

* Scope is not included.



Apex
Monster Orange



Apex
Monster Green



ACCURA



Scan code for all options and colors



Model	ACCURA		
Cocking System	SIDE LEVER		
Caliber	4.5mm / .177cal	5.5mm / .22cal	6.35mm / .25cal
Maximum Muzzle Velocity	350m/s (1150fps)	290m/s (950fps)	260m/s (850fps)
Energy	33.6 Joule / 24.8 ft.lbs	49.3 Joule / 36.3 ft.lbs	55.2 Joule / 40.7 ft.lbs
Magazine Capacity	14	12	10
Number of Shots At Optimal Velocity (250-110 Bar)	168	144	120
Air Tube Volume	425cc		
Fill Pressure	250 Bar		
Stock	High Quality Synthetic Stock Turkish Walnut Adjustable Cheek Piece Adjustable Butt Pad		

Overall Length	1010 mm (39.7")
Barrel Length	380 mm (14.9")
Weight	Synthetic: 3.5 kg (7.7lbs)

* Velocity figures are tested with 8.44 grain 177 cal- 18.13 grain 22 cal and 25.39 grain 25cal JSB pellets

* Velocity/Energy results may due to pellet weight, pellet shape, temperature, elevation, as well as other factors.

* Scope is not included.

ACCURA W



Model	ACCURA W		
Cocking System	SIDE LEVER		
Caliber	4.5mm / .177cal	5.5mm / .22cal	6.35mm / .25cal
Maximum Muzzle Velocity	350m/s (1150fps)	290m/s (950fps)	260m/s (850fps)
Energy	33.6 Joule / 24.8 ft.lbs	49.3 Joule / 36.3 ft.lbs	55.2 Joule / 40.7 ft.lbs
Magazine Capacity	14	12	10
Number of Shots At Optimal Velocity (250-110 Bar)	168	144	120
Air Tube Volume	425cc		
Fill Pressure	250 Bar		
Stock	Turkish Walnut Stock , Adjustable Cheek Piece		

Overall Length	1010 mm (39.7")
Barrel Length	380 mm (14.9")
Weight	Wood: 3.1kg (6.8lbs)

* Velocity figures are tested with 8.44 grain 177 cal- 18.13 grain 22 cal and 25.39 grain 25cal JSB pellets

* Velocity/Energy results may due to pellet weight, pellet shape, temperature, elevation, as well as other factors.

* Scope is not included.



TORMENTA

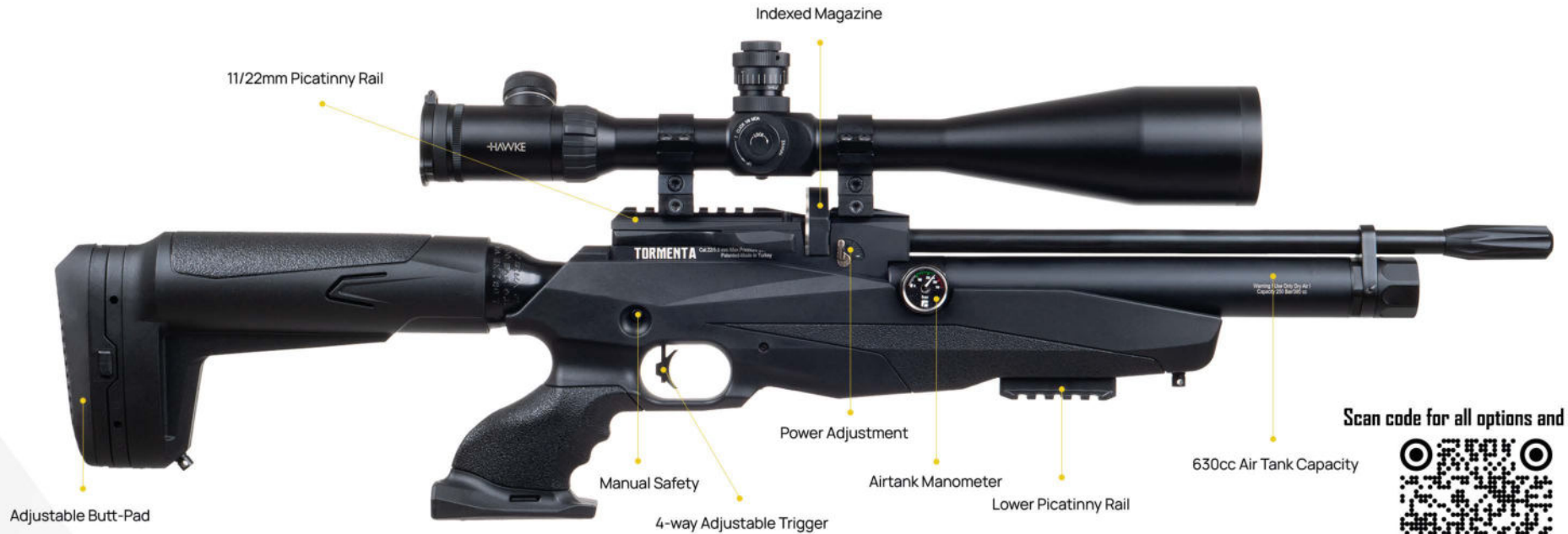

Scan code for all options and colors



Model	TORMENTA		
Cocking System	SIDE LEVER		
Caliber	4.5mm / .177cal	5.5mm / .22cal	6.35mm / .25cal
Maximum Muzzle Velocity	332m/s (1090fps)	270m/s (880fps)	255m/s (840fps)
Energy	30.2 Joule / 22.3 ft.lbs	42.3 Joule / 31.2 ft.lbs	53.9 Joule / 39.76 ft.lbs
Magazine Capacity	14	12	10
Number of Shots At Optimal Velocity (250-110 Bar)	126	108	90
Air Tube Volume	380cc (250 cc Rear Bottle + 130 cc Front Cylinder)		
Fill Pressure	250 Bar		
Stock	High Quality Synthetic Stock Adjustable Butt Pad		

Overall Length	850 mm (33.4")
Barrel Length	380 mm (14.9")
Weight	2.8 kg (6.17 lbs)

* Velocity figures are tested with 8.44 grain 177 cal- 18.13 grain 22 cal and 25.39 grain 25cal JSB pellets

* Velocity/Energy results may due to pellet weight, pellet shape, temperature, elevation, as well as other factors.

* Scope is not included.

TORMENTA W

Turkish Walnut Stock



Tormenta Color Options



*Tormenta
Ambush*



*Tormenta
Thunder White*



*Tormenta
Red Fire*



Scan code for all options and colors



DAYSTAR



DAYSTAR
Thunder Snow



DAYSTAR
Ambush

Scan code for all options and colors



Model	DAYSTAR		
Cocking System	SIDE LEVER		
Caliber	4.5mm / .177cal	5.5mm / .22cal	6.35mm / .25cal
Maximum Muzzle Velocity	350m/s (1150fps)	290m/s (950fps)	260m/s (850fps)
Energy	33.6 Joule / 24.8 ft.lbs	49.3 Joule / 36.3 ft.lbs	55.2 Joule / 40.7 ft.lbs
Magazine Capacity	14	12	10
Number of Shots At Optimal Velocity (250-110 Bar)	98	84	70
Air Tube Volume	260cc		
Fill Pressure	250 Bar		
Stock	High Quality Synthetic Stock, Adjustable Cheek Piece, Adjustable Butt Pad		

Overall Length	1050 mm (41.3")
Barrel Length	580 mm (22.8")
Weight	Synthetic: 2.8 kg (6.1lbs)
Regulator	Optional

* Velocity figures are tested with 8.44 grain 177 cal- 18.13 grain 22 cal and 25.39 grain 25cal JSB pellets

* Velocity/Energy results may due to pellet weight, pellet shape, temperature, elevation, as well as other factors.

*Data may vary on products with optional regulator.

* Scope is not included.

DAYSTAR W



DAYSTAR W
Orange Laminated



DAYSTAR W
Blue Laminated

Scan code for all options and colors



Model	DAYSTAR W		
Cocking System	SIDE LEVER		
Caliber	4.5mm / .177cal	5.5mm / .22cal	6.35mm / .25cal
Maximum Muzzle Velocity	350m/s (1150fps)	290m/s (950fps)	260m/s (850fps)
Energy	33.6 Joule / 24.8 ft.lbs	49.3 Joule / 36.3 ft.lbs	55.2 Joule / 40.7 ft.lbs
Magazine Capacity	14	12	10
Number of Shots At Optimal Velocity (250-110 Bar)	98	84	70
Air Tube Volume	260cc		
Fill Pressure	250 Bar		
Stock	Turkish Walnut Stock, Adjustable Cheek Piece, Optional Laminated Stocks		

Overall Length	1050 mm (41.3")
Barrel Length	580 mm (22.8")
Weight	Wood: 3.2kg (7lbs)
Regulator	Optional

* Velocity figures are tested with 8.44 grain 177 cal- 18.13 grain 22 cal and 25.39 grain 25cal JSB pellets

* Velocity/Energy results may due to pellet weight, pellet shape, temperature, elevation, as well as other factors.

*Data may vary on products with optional regulator.

* Scope is not included.

NEW



LYRA



Rubber Butt Pad

Turkish Walnut

4-Way Adjustable
Trigger

Power Adjustment Knob



Scan code for all options and colors

www.reximex.com

PCP AIRGUNS / LYRA



NEW

www.reximex.com

PCP AIRGUNS / LYRA



Model	LYRA		
Cocking System	SIDE LEVER		
Caliber	4.5mm / .177cal	5.5mm / .22cal	6.35mm / .25cal
Maximum Muzzle Velocity	350m/s (1115fps)	290m/s (965fps)	260m/s (850fps)
Energy	31.6 Joule / 23.3 ft.lbs	50.8 Joule / 37.5 ft.lbs	55.4 Joule / 40.7 ft.lbs
Magazine Capacity	14	12	10
Number of Shots At Optimal Velocity (250-110 Bar)	110	75	65
Air Tube Volume	280cc		
Fill Pressure	200 Bar		
Stock	Turkish Walnut		

Overall Length	1070 mm (41.3")
Barrel Length	580 mm (22.8")
Weight	3.45 kg (7.6 lbs)

* Velocity figures are tested with 8.44 grain 177 cal- 18.13 grain 22 cal and 25.39 grain 25cal JSB pellets

* Velocity/Energy results may due to pellet weight, pellet shape, temperature, elevation, as well as other factors.

* Scope is not included.

NEW



LYRA-K

Carabine Comfortable Stock

Rubber Stock

4 Way Adjustable Triger
& Manual Safety



www.reximex.com

RIFLE / PANGEA



Cocking System	Side Lever			Fill Pressure	250 Bar
Caliber	4.5mm / .177cal	5.5mm / .22cal	6.35mm / .25cal	Stock	Turkish Walnut
Max Muzzle Velocity (*)	305m/s (1000fps)	275m/s (900fps)	244m/s (800fps)	Overall Length	880mm (34,6")
Energy (*)	31.6 Joule/ 23.3 ft.lbs	50.8 Joule/ 37.5 ft.lbs	55.4 Joule/ 40.7 ft.lbs	Barrel Length	380mm (14.9")
Magazine Capacity	14	12	10	Weight	2.8 kg (6.1 lbs)
Number of Shots At Optimal Velocity (200-100Bar)	100, 70, 60				
Air Tube Volume	250cc				



Reximex ABS Cases

Reximex Hard Case
with wheels
Length: 111.5cm
Width: 33.5cm



Reximex Hard Case
Length: 97cm
Width: 26cm



Reximex Filling Equipments



Scuba
Filling Kit

FOR META & ZONE and REG.DAYSTAR & REG.APEX



Filling Probes



Reximex
Hand Pump

Reximex Air Rifle Sound Moderators

Accessories

Air Tanks

01



03



02



330cc / 480cc / 700cc Carbon Fiber
Air Bottles Are Available



Regulator



Manometer



Regulator
Manometer

25 cal



22 cal



177 cal



PCP Rifle Magazine



22mm Lower Picattiny Rail



RP / RPA Magazine

25 cal



22 cal



177 cal



Single Shot Tray

Long SilentForce



Short SilentForce





reximex

Aim for the next level



@reximexarms

Bayavşar Mah. 41958 Sk. No:3
42700 Beyşehir / Konya / TÜRKİYE

info@reximex.com
www.reximex.com

+90 (332) 511 00 55
+90 (332) 514 80 55